

**Poli - poles Modelli - models**

<b>2</b>	<b>VSL.50_04.110L</b>
----------	-----------------------

**IT**

Elettropompa sommergibile compatta e di robusta costruzione fabbricata completamente in ghisa, senza camera olio, unica tenuta meccanica posizionata sopra alla girante a diretto contatto del liquido pompato

**EN**

Compact and solid construction submersible pump completely made in cast iron, without oil chamber, only one mechanical seal positioned above the impeller in direct contact with the pumped liquid

**FR**

Pompe électrique submersible compacte et construction robuste entièrement en fonte, sans chambre à huile, seule garniture mécanique placée au-dessus de la roue en contact direct avec le liquide pompé

**ES**

Bomba eléctrica sumergible compacta y construcción robusta completamente de hierro fundido, sin cámara de aceite, solo sello mecánico colocado sobre el impulsor en contacto directo con el líquido bombeado

**Poli - poles Modelli - models**

<b>2</b>	<b>VSL.50_06/09/11.110</b>
----------	----------------------------

**IT**

Elettropompa sommergibile compatta e di robusta costruzione fabbricata completamente in ghisa, con camera olio interposta tra gruppo motore e gruppo pompa. Tenuta meccanica in camera olio non a diretto contatto del liquido pompato e protetta da un anello V-Ring posizionato dietro alla girante

**EN**

Compact and solid construction submersible pump completely made in cast iron, with oil chamber interposed between motor unit and pump unit. Mechanical seal positioned inside the oil chamber not in direct contact with the pumped liquid and protected by a V-Ring ring positioned on the back of the impeller

**FR**

Pompe électrique submersible compacte entièrement réalisée en fonte, avec chambre à huile intercalée entre le groupe moteur et le groupe pompe. Joint mécanique dans la chambre d'huile non en contact direct avec le liquide pompé et protégé par un anneau en V situé à l'arrière de la roue

**ES**

Bomba eléctrica sumergible compacta hecha completamente de hierro fundido, con cámara de aceite interpuesta entre la unidad del motor y la unidad de la bomba. Cierre mecánico en la cámara de aceite que no está en contacto directo con el líquido bombeado y está protegido por un anillo en V ubicado en la parte posterior del impulsor

VSL.50\_06-09-11.110

VSL.50\_04.110L



**IDENTIFICAZIONE - IDENTIFICATION**

Dati Idraulici Hydraulic data		Dati motore elettrico Motor data				
VSL	50	04	2	M (A)	110L	X
Vortex System / Versione leggera - Light version		06	T (A)		110	
DNm - DN outlet 50 Uscita orizzontale DN50-G 2" - Horizontal outlet DN50 - G 2"		09				
P <sub>2</sub> : kW x 10		11				
Numero poli - Number of poles						
M: 1~230V - 50Hz - Monofase - Singlephase MA: 1~230V - 50Hz - Monofase con Galleggiante - Singlephase with float level switch T: 3~400 V - 50HZ - Trifase - Threephase TA: 3~400 V - 50HZ - Trifase con Galleggiante- Threephase with float level switch						
Grandezza motore - Motor Frame						
Costruzione speciale - Special feature						

**LISTA MODELLI - RANGE OF PRODUCTS**

Grandezza Motore Motor Frame	Poles	P <sub>2</sub> [kW]	Alimentazione Power supply	Modelli Models	Avviamento Starting	Cavo alimentazione / segnali Power / signals cable		Camera olio Oil Chamber
						[m]	Type	
110L	2	0,4	1ph	VSL.50_04.2.M(A).110L	μF: 16	5*	H07RN-F 3G1,5	NO
			3ph	VSL.50_04.2.T(A).110L	D.O.L.	5*	H07RN-F 4G1	
110	2	0,6	1ph	VSL.502.M(A).110	μF: 20	10	H07RN-F 3G1,5	SI YES
			3ph	VSL.50_06.2.T(A).110	D.O.L.	10	H07RN-F 4G1	
		0,9	1ph	VSL.50_09.2.M(A).110	μF: 25	10	H07RN-F 3G1,5	
			3ph	VSL.50_09.2.T(A).110	D.O.L.	10	H07RN-F 4G1	
		1,1	1ph	VSL.50_11.2.M(A).110	μF: 25	10	H07RN-F 3G1,5	
			3ph	VSL.50_11.2.T(A).110	D.O.L.	10	H07RN-F 4G1	

\* Per uso esterno è obbligatorio utilizzare la pompa con lunghezza cavo di 10m - vedi normativa EN 60335 - 2.41  
For external use it is mandatory to use the pump with a cable length of 10m - see standard EN 60335 - 2.41

## Caratteristiche costruttive - construction features

**Motore asincrono** in classe di isolamento F (155°C), a secco e raffreddato dal liquido circostante;

**Asynchronous dry motor**, insulation class F(155°C), cooled by the surrounding liquid;

**Moteur asynchrone**, classe d'isolation F (155°C), sec et refroidi par le liquide environnant;

**Motor asincrono**, aislamiento clase F (155 ° C), seco y refrigerado por el líquido que rodea.

### Camera condensatore M-MA / Teleruttore TA

Capacitor chamber M-MA / Contactor TA

Chambre condensateur M-MA / Contacteur TA

Camara condensador M-MA / Contactor TA

### Motore monofase con protettore termico

Singlephase motor with built in thermal protector

Moteur monophasé avec protection thermique

Motor monofásico con protector térmico

<b>Viti</b>	<b>Quality</b>
<b>Screws</b>	
<b>Vis</b>	<b>A2</b>
<b>Tornillos</b>	

<b>O-RINGS</b>	<b>NBR</b>
----------------	------------

### V-Ring

Protezione albero

Shaft protection

Protection de l'arbre

protección del eje

**DNm: G 2" - DN50 PN6**

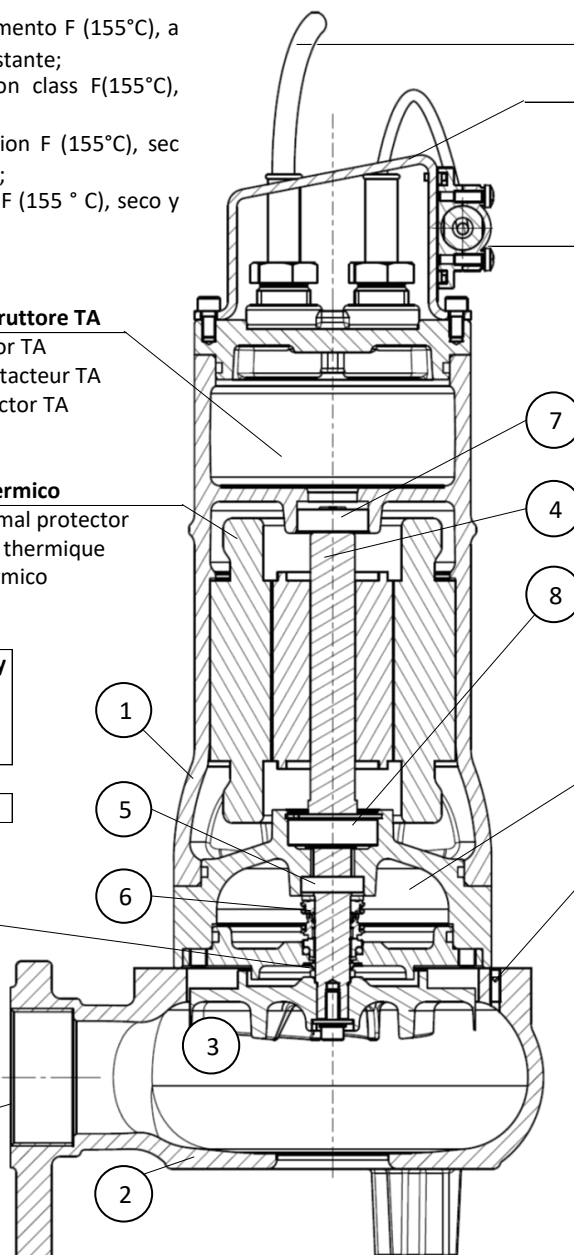

**10 m - H07RN-F**

### Maniglia per movimentazione pompa

Handel to lift the pump

Poignée pour lever la pompe

Manejar para levantar la bomba

### Fixing kit

Sistema di regolazione galleggiante

Float regulation system

Système de régulation du flotteur

Sistema de regulación del flotador

**Camera olio** per il raffreddamento e la lubrificazione delle tenute meccaniche

**Oil chamber** for the cooling and lubrication of mechanical seals

**Chambre d'huile** pour le refroidissement et la lubrification des garnitures mécaniques

**Cámara de aceite** para el enfriamiento y lubricación de sellos mecánicos

### Foro di sfiato

Vent hole

Trou d'évent

Orificio de ventilación

**Girante arretrata** con ampio passaggio libero  
**Backward impeller** with large free passage

**Roue arrière** avec grand passage libre

**Impulsor hacia atrás** con gran paso libre

NR.	DESCRIPTION	MATERIAL
1	Gruppo motore	Ghisa
	Motor group	Cast iron
	Groupe moteur	Fer de fonte
	Unidad de motor	Hierro
2	Corpo idraulico	Ghisa
	Pump Housing	Cast iron
	Corps de la pompe	Fer de fonte
	Cuerpo hidráulico	Hierro
3	Girante	Ghisa
	Impeller	Cast iron
	Roue	Fer de fonte
	Impulsor	Hierro
4	Albero motore	Acciaio
	Shaft	Steel
	Arbre moteur	Acier
	Eje del motor	Acero

NR.	DESCRIPTION	MATERIAL
5	Anello tenuta radiale	
	Upper sealing ring	NBR
	Bague d'étanchéité	
	Sello radial superior	
6	Tenuta mecc.	SiC / SiC
	Mech. seal	
	Haut garniture mécan.	NBR
	Sello mecánico	
7	Cuscinetto superiore	
	Top bearing	6201 - 2RS1
	Roulement supérieur	
	Cojinete superior	
8	Cuscinetto inferiore	
	Lower bearing	6203 - 2RS1
	Roulement inférieur	
	Cojinete inferior	

## Caratteristiche costruttive - construction data

<b>Costruzione Motore - Motor Frame</b>	110	
<b>Grado di protezione IP - IP protection</b>	IP x8	
<b>Classe di Isolamento - Insulation Class</b>	F (155°C)	
<b>Tipo di servizio - Service type</b>	S1 Continuous / S3 Intermittent	
<b>Avvolgimento statore - Stator winding</b>	1~PH - Singlephase	3~PH - Threephase
	[V] 1~230V	Y / Δ 3~400/230
<input type="checkbox"/> <b>Protezione motore - Motor Protection</b>	Standard	Optional
<input type="radio"/> Bimetallico - Bimetal disc	<input checked="" type="checkbox"/>	<input checked="" type="checkbox"/> 130°C
<input type="radio"/> Solo su richiesta - on request only PT100	<input type="checkbox"/>	<input type="checkbox"/>
<input type="radio"/> Solo su richiesta - on request only PTC	<input type="checkbox"/>	<input type="checkbox"/>
<b>Raffreddamento - Cooling</b>	Dal liquido circostante - By surrounding fluid	
<b>Camera olio - Oil chamber</b>	Si - Yes	
<b>Protezione Tenuta - Leakage protection</b>	No	
<b>Tipo girante - Impeller</b>	Vortex	
<b>DN mandata - Discharge</b>	G 2"- DN 50 PN6	
<b>Controflangia filettata - Threaded counterflange</b>	No -	
<b>DN aspirazione / Suction</b>	[mm]	Ø 50
<b>Tipo di vernice e spessore - Paint type and thickness</b>	Standard: Vernice all'acqua - Water paint / 30µm Opaco Nero - Opaque Black	
	Optional: Epossidica - Epoxy coating / 80mm RAL 7015 - Grigio - Grey	

## Limiti di utilizzo - Operating Limits

<b>Temperatura massima liquido - Pumped fluid max temperature</b>	[°C]	≤ 40
<b>Densità liquido - Density</b>	[Kg/dm <sup>3</sup> ]	~ 1
<b>Viscosità - Viscosity</b>	[mm <sup>2</sup> /s]	~ 1
<b>Contenuto di cloruri - Chlorides content</b>	[mg/l]	< 200
<b>PH liquido pompato - PH value</b>		6 ÷ 12
<b>Max. prof. Immersione - Max. Immersion depth</b>	[m]	20
<b>Max. contenuto solidi abrasivi - Max. abrasive solid content</b>	[g/l]	< 1

**Corretta rotazione della girante**  
**Rotation of the impeller**

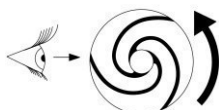

**CURVA CARATTERISTICA - PERFORMANCE CURVE**

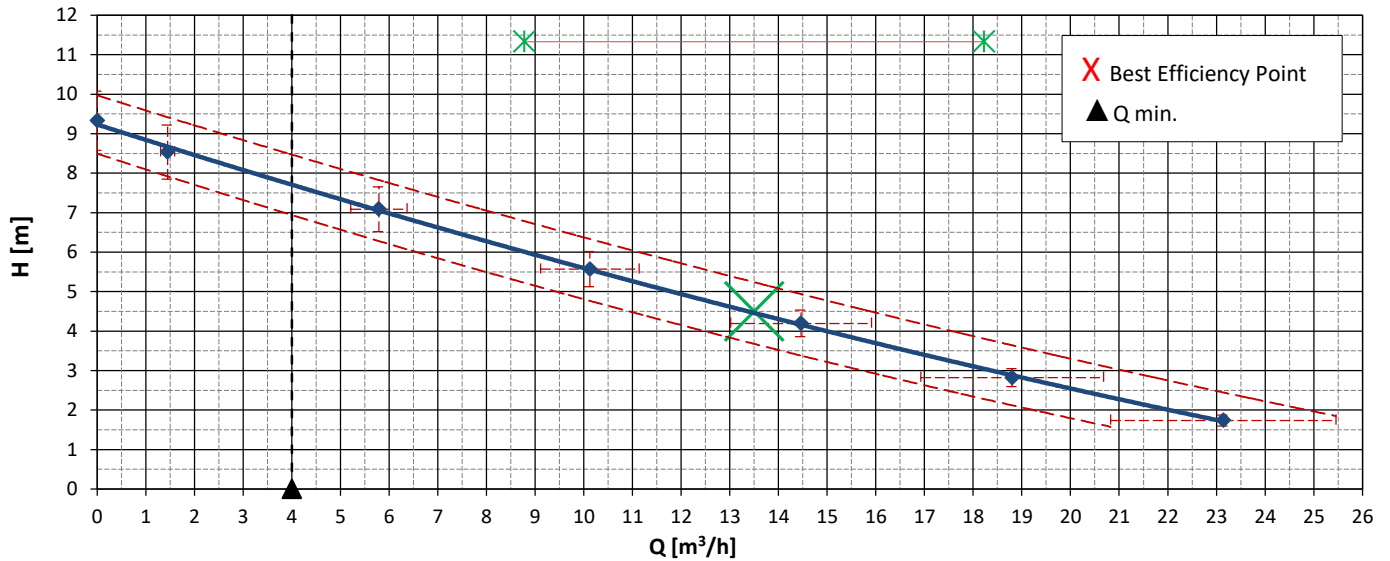

**POTENZA ALL'ALBERO - SHAFT POWER**

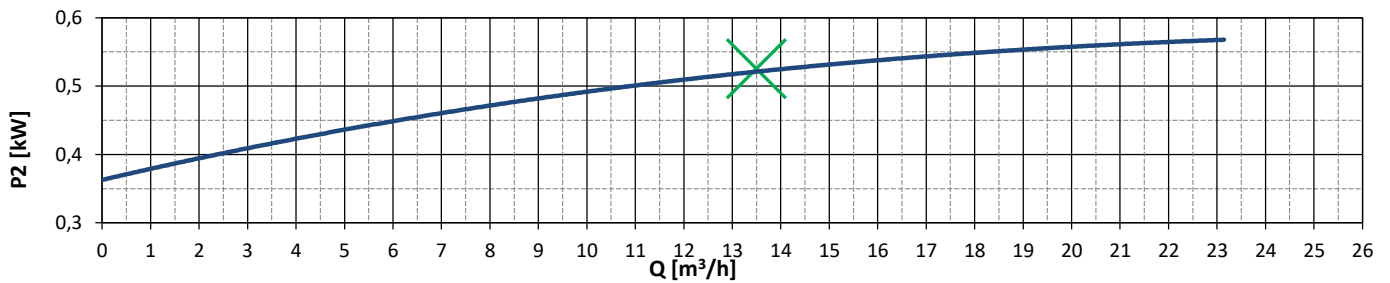

**RENDIMENTO IDRAULICO - HYDRAULIC EFFICIENCY**

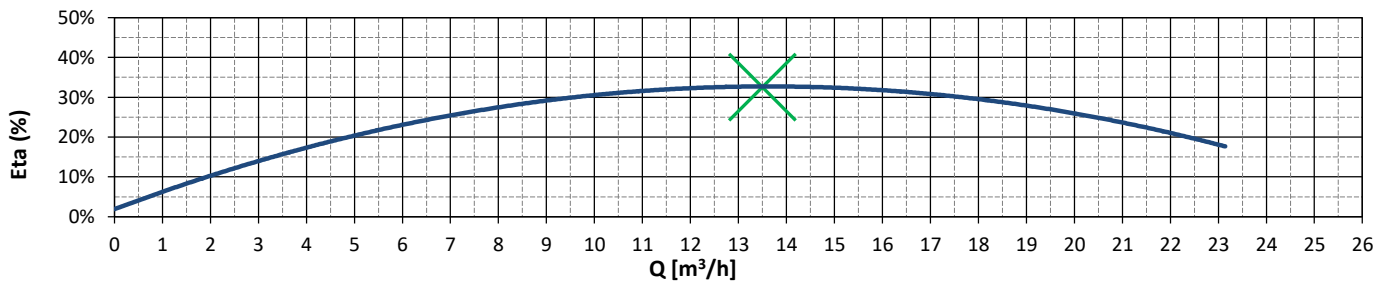

FLOW (Q)	l/min	0,0	24,1	96,4	168,7	241,1	313,4	385,7				
	l/s	0,0	0,4	1,6	2,8	4,0	5,2	6,4				
	m³/h	0,0	1,4	5,8	10,1	14,5	18,8	23,1				
HEAD (H)	m	9,3	8,5	7,1	5,6	4,2	2,8	1,7				

**Dati pompa / Pump data**

Potenza nominale Nominal power	(P <sub>n</sub> )	[KW]	<b>0,60</b>
Potenza all'albero Shaft power	(P <sub>2</sub> )	[KW]	<b>0,57</b>
Potenza assorbita Supply Power	(P <sub>1</sub> )	[KW]	<b>0,79</b>
Fattore di potenza Power Factor	Cosφ		<b>0,85</b>

		Model M/MA	Model T/TA
Alimentazione Power supply	[V]	<b>1~230-50Hz</b>	<b>3~400-50Hz</b>
Avviamento Starting		<b>25 μF</b>	<b>D.O.L.</b>
Corrente Nominale Rated current	[A]	<b>4,5</b>	<b>1,6</b>
Corrente di spunto Starting current	[A]	<b>13,5</b>	<b>8,0</b>

Passaggio libero Free Passage	[mm]	<b>∅ 50</b>
Diametro girante Impeller diameter	[mm]	<b>∅ 108</b>
Peso pompa Weight	[Kg]	<b>23,5</b>

Galleggiante Float level switch	<b>Optional (MA)</b>	<b>Optional (TA)</b>
Cavo Cable	<b>10m 3G1,5</b>	<b>10m 4G1</b>
Nr. Avviamenti / ora Nr. Start per hour	<b>30</b>	

In accordo con: ISO 9906:2012 - Grade 3B ( section 4.4.2)  
In accordance to:

Curve per liquidi con densità/curve established for liquid with density  
1kg/dm3 - viscosità/viscosity 1 mm2/s - temperatura/temperature 20°C

## Dimensioni d'ingombro - overall dimensions

**S** Installazione mobile - Installation mobile - Installation mobile - Instalación móvil

Dimensione imballo  
Packaging dimensions

Misure - Measures [mm]

A	B	C
570	250	215







**FC** Con piede di accoppiamento - With foot coupling - Avec pied d'assise - Con pie de acoplamiento

8FC00002      KG: 7,5

1	Supporto tubi guida da 3/4" 3/4" guide rails bracket
2	Piede orizzontale 2" Horizontal foot - 2"out
3	Slitta completa Sliding bracket complete
4	Esclusi dalla fornitura Not supplied

D	260mm
E	175mm
F	195mm

## ACCESSORI - ACCESSORIES - ACCESORIES - ACCESORIOS

Descrizione - Description - Description - Descripción		Codice Code
FC	 <ul style="list-style-type: none"> <li>- Dispositivo di accoppiamento DN50 - uscita G 2"</li> <li>- DN50 Coupling device - outlet 2"</li> <li>- Dispositif de couplage DN50 - sortie G 2"</li> <li>- Dispositivo de acoplamiento DN50- salida G 2"</li> </ul>	8FC000002
	 <ul style="list-style-type: none"> <li>- Catena ferro zincato - galvanized Iron</li> <li>- Chain fer galvanisé - hierro galvanizado</li> </ul>	2SC000019
	<ul style="list-style-type: none"> <li>- Catena Acciaio - Stainless steel</li> <li>- Cadena acier inox - acero inox</li> </ul>	2SC000032
TBV	 <ul style="list-style-type: none"> <li>- Valvola di ritegno a palla filettata</li> <li>- Threaded valve</li> <li>- Vanne fileté</li> <li>- Válvula roscada</li> </ul>	G 2" 4BV000003
HF	 <ul style="list-style-type: none"> <li>- Regolatore di livello per acque reflue</li> <li>- Level switch for sewage</li> <li>- Interrupteur de niveau pour eaux usées</li> <li>- Interruptor de nivel para aguas residuales</li> </ul>	[10 mt] 3CS000007
SHELL	 <ul style="list-style-type: none"> <li>- Contrappeso SHELL per galleggiante</li> <li>- Counterweight SHELL for level switch</li> <li>- Cotrepoids SHELL pour interrupteur de niveau</li> <li>- Contrapeso para interruptor de nivel</li> </ul>	3CS000021
TUTOR	 <ul style="list-style-type: none"> <li>- Sistema di guida del galleggiante per spazi ristretti</li> <li>- Float guidance system for confined spaces</li> <li>- Système de guidage à flotteur pour espaces confinés</li> <li>- Sistema de guiado flotante para espacios reducidos.</li> </ul>	3CS000020

## SELEZIONE QUADRO DI CONTROLLO - CONTROL PANEL SELECTION

	Pole	Pump	Alim. [V]	P <sub>2</sub> [KW]	In [A]	Start. Avv.	- ECH - ELECTROMECHANICAL						- ECL - ELECTRONIC													
							1 Pump			2 Pumps			1 Pump			2 Pumps										
							ECH1.M-7 5EC000006	ECH1.M-14 5EC000008	ECH1.T-7 5EC000005	ECH2.M-7 5EC000030	ECH2.M-14 5EC000032	ECH2.T-7 5EC000029	ECL1.M-16 5EC000081	ECL1.T-15 5EC000083	ECL2.M-16 5EC000082	ECL2.T-15 5EC000084										
110L	2	VSL.50_04.2.M/MA.110L	1~230	0,4	3,5	16µF	•			•				•												
		VSL.50_04.2.T.110L	3~400	0,4	1,2	DOL			•				•			•										
110	2	VSL.50_06.2.M/MA.110	1~230	0,6	4,5	20µF	•			•				•												
		VSL.50_06.2.T/TA.110	3~400	0,6	1,6	DOL			•				•		•											
		VSL.50_09.2.M/MA.110	1~230	0,9	6,7	25µF		•				•			•											
		VSL.50_09.2.T/TA.110	3~400	0,9	2,2	DOL			•				•			•										
		VSL.50_11.2.M/MA.110	1~230	1,1	7,7	25µF		•				•			•											
		VSL.50_11.2.T/TA.110	3~400	1,1	2,8	DOL			•				•			•										